



SELECT NATURAL WOVEN



Product Reference and Retail Price Guide

April 15, 2024

Product Reference & Price Guide

Prices subject to change without notice.



ABOUT THE COLLECTION

The Walden Select Collection includes contemporary patterns, with bamboos that have been re-imagined for modern decor, woven jutes in trending gray and white color choices, and soft, natural fabrics.

Using natural shades in your design is a subtle way to bring the timeless beauty of nature into your space.

Shades incorporate natural fibers like bamboo, jute, and ramie into their weaves, which are selected based on color and luster. Materials are hand processed and woven into shade fabric. Finished fabrics highlight the textures, colors, and qualities of the natural materials used to create them.

After drying and quality review, fabrics are then sewn and constructed by hand into finished shades.

All the patterns in the collection can be made into roman shades or sliding panels. Many can be made into folding doors.

Natural shades are as functional as they are beautiful with several customization options including the ability to tailor your light and privacy preferences with various liner and shade styles.

The collection has three unique cord-free control options: our patented cordless system that can lift even the heaviest shade on a 1½" head rail and our affordable, versatile wand and remote control motorization options.

Our Limited Lifetime Warranty covers all aspects of workmanship and quality in your shades.

TABLE OF CONTENTS

MATERIALS REFERENCE TABLES		SHADE SPECIFICATIONS	
Woven Wood Materials Reference	4 - 5	Specifications Table	13
Edge Binding / Liner Materials Reference	5	Specification Line Drawings	14
SHADE CONSTRUCTION		FOLDING DOORS	
Shade Styles	6	Options	15 - 16
Shade Options	7	Specifications	17
SHADE CONTROL OPTIONS		SLIDING PANELS	
Cordless	8	Options	18
Clutch	8	Specifications	19 - 20
Wand Motor	9	Configurations	21
Remote Motor	10	PRICING	
ADDITIONAL OPTIONS		Shade Price Grids	22 - 23
Valances	11	Shade Option Pricing	24 - 25
Edge Binding	11	Folding Door Pricing	26 - 27
Cut Outs	12	Sliding Panel Pricing	28 - 30
Hold Down Brackets	12	WARRANTY	
Valance Only	12	Limited Lifetime Warranty	32



MATERIALS REFERENCE

PATTERN CODE	PATTERN NAME	PRICE GROUP	MATERIAL CONTENT	FOLDING DOOR	SLIDING PANEL	COORDINATED EDGE BINDING COLOR	COORDINATED WAND COLOR
WS-F132	Alisia Antique White ⁽¹⁾	E	60% Bamboo, 40% Cotton-Polyester Yarn	Y	Y	Wheat	Beige
WS-F111	Alisia Chiffon ⁽¹⁾	E	60% Bamboo, 40% Cotton-Polyester Yarn	Y	Y	Pearl	White
WS-F122	Alisia Morning ⁽¹⁾	E	60% Bamboo, 40% Cotton-Polyester Yarn	Y	Y	Titanium	Gray
WS-V043	Andros Birch	E	70% Bark, 30% Bamboo	Y	Y	Stone	Beige
WS-V049	Andros Harbor	E	70% Bark, 30% Bamboo	Y	Y	Titanium	Gray
WS-1922	Antilles Mist	D	60% Jute, 40% Bamboo	N	Y	Olive	Beige
WS-1903	Antilles Sand	D	60% Jute, 40% Bamboo	N	Y	Wheat	Beige
WS-1905	Antilles Seagrass	D	60% Jute, 40% Bamboo	N	Y	Wheat	Beige
WS-5322	Cala Platinum	B	100% Bamboo	Y	Y	Titanium	Gray
WS-5302	Cala Titanium	B	100% Bamboo	Y	Y	Titanium	Gray
WS-0390	Camden Natural ⁽²⁾	D	100% Ramie	N	Y	Wheat	Beige
WS-0392	Camden Snow ⁽²⁾	D	100% Ramie	N	Y	Pearl	White
WS-W116	Chelsea Lace	D	40% Bamboo, 40% Flax, 20% Paper	Y	Y	Pearl	White
WS-W118	Chelsea Taupe	D	40% Bamboo, 40% Flax, 20% Paper	Y	Y	Stone	Gray
WS-1322	Como Charcoal ⁽¹⁾	E	80% Flax, 20% Bamboo	N	Y	Stone	Beige
WS-1302	Como Ecu ⁽¹⁾	E	80% Flax, 20% Bamboo	N	Y	Wheat	Beige
WS-1323	Como Gray ⁽¹⁾	E	80% Flax, 20% Bamboo	N	Y	Wheat	Beige
WS-1388	Como Midnight ⁽¹⁾	E	80% Flax, 20% Bamboo	N	Y	Onyx	Black
WS-1303	Como Umber ⁽¹⁾	E	80% Flax, 20% Bamboo	N	Y	Wheat	Beige
WS-A904	Fay Black ⁽¹⁾	E	100% Bamboo	Y	Y	Onyx	Black
WS-A133	Fay Snow ⁽¹⁾	E	100% Bamboo	Y	Y	Pearl	White
WS-D601	Fay Tan ⁽¹⁾	E	90% Bamboo, 10% Cotton-Polyester Yarn	Y	Y	Camel	Beige
WS-0389	Halifax Natural ⁽²⁾	D	100% Jute	N	Y	Wheat	Beige
WS-0427	Harbor Golden	D	100% Ramie	N	Y	Wheat	Beige
WS-0428	Harbor White	D	100% Ramie	N	Y	Wheat	Beige
WS-E402	Lou Coconut	C	60% Paper, 40% Bamboo	Y	Y	Pearl	White
WS-E302	Lou Contrast	C	50% Bamboo, 50% Paper	Y	Y	Onyx	Black
WS-E401	Lou Cotton	C	60% Paper, 40% Bamboo	Y	Y	Pearl	White
WS-E501	Lou Driftwood	C	60% Paper, 40% Bamboo	Y	Y	Titanium	Gray
WS-0702	Malvern Chalk	B	100% Bamboo	Y	Y	Pearl	White
WS-0722	Malvern Gray	B	100% Bamboo	Y	Y	Titanium	Gray
WS-0721	Malvern Light Gray	B	100% Bamboo	Y	Y	Titanium	Gray
WS-0723	Malvern Platinum	B	100% Bamboo	Y	Y	Titanium	Gray
WS-0812	Metro Caramel	C	100% Bamboo	Y	Y	Camel	Bronze
WS-0802	Metro Chalk	C	100% Bamboo	Y	Y	Pearl	White

All fabrics have a maximum width of 96".

⁽¹⁾ Edge Binding is required. Patterns that require edge binding have the cost of edge binding included in the base price of the shade.

⁽²⁾ Edge Binding is recommended.

MATERIALS REFERENCE

PATTERN CODE	PATTERN NAME	PRICE GROUP	MATERIAL CONTENT	FOLDING DOOR	SLIDING PANEL	COORDINATED EDGE BINDING COLOR	COORDINATED WAND COLOR
WS-0822	Metro Smoke	C	100% Bamboo	Y	Y	Wheat	Beige
WS-1806	Montana Inkwash	D	50% Jute, 50% Ramie	N	Y	Onyx	Black
WS-1888	Montana Mineral	D	50% Jute, 50% Ramie	N	Y	Onyx	Black
WS-1605	Nantucket Sea Mist	D	100% Jute	N	Y	Wheat	Beige
WS-0522	Osaka Granite	B	100% Bamboo	Y	Y	Titanium	Gray
WS-0502	Osaka Snow	B	100% Bamboo	Y	Y	Pearl	White
WS-1516	Parchment Husk ⁽²⁾	D	100% Red Ramie	N	Y	Wheat	Beige
WS-1201	Peri Mist	E	60% Ramie, 40% Paper	N	Y	Titanium	Gray
WS-1517	Portland Inkwash ⁽²⁾	D	100% Ramie	N	Y	Navy	Bronze
WS-1522	Portland Sky ⁽²⁾	D	100% Ramie	N	Y	Wheat	Beige
WS-0602	Pudong White	A	100% Bamboo	Y	Y	Pearl	White
WS-1101	Selene Natural ⁽¹⁾	E	100% Ramie	N	Y	Wheat	Beige
WS-1102	Selene White ⁽¹⁾	E	100% Ramie	N	Y	Wheat	White
WS-0004	Soft Jute Beige ⁽¹⁾	F	100% Ramie	N	Y	Wheat	Beige
WS-0022	Soft Jute Gray ⁽¹⁾	F	100% Ramie	N	Y	Stone	Beige
WS-0001	Soft Jute White ⁽¹⁾	F	100% Ramie	N	Y	Wheat	Beige
WS-1504	Sonoma Dusk ⁽²⁾	D	100% Ramie	N	Y	Camel	Bronze
WS-9077	Terra Oak	C	100% Jute	N	Y	Camel	Beige
WS-0833	Tortola Natural	D	90% Jute, 10% Bamboo	N	Y	Camel	Bronze
WS-0288	Umbria Ink	C	80% Bamboo, 20% Ramie	Y	Y	Onyx	Black
WS-0222	Umbria Mist	C	80% Bamboo, 20% Ramie	Y	Y	Stone	Beige
WS-0219	Umbria Sepia	C	80% Bamboo, 20% Ramie	Y	Y	Wheat	Bronze

All fabrics have a maximum width of 96".

⁽¹⁾ Edge Binding is required. Patterns that require edge binding have the cost of edge binding included in the base price of the shade.

⁽²⁾ Edge Binding is recommended.

RAMIE EDGE BINDINGS

COLOR NUMBER	COLOR	MATERIAL CONTENT
EB09	Camel	100% Ramie
EB78	Navy	100% Ramie
EB15	Olive	100% Ramie
EB10	Onyx	100% Ramie
EB62	Pearl	100% Ramie
EB105	Stone	100% Ramie
EB58	Titanium	100% Ramie
EB82	Wheat	100% Ramie

LINERS

COLOR NUMBER	COLOR	MATERIAL CONTENT
LIGHT-FILTERING LINERS		
LF82	Beige	50% Cotton, 50% Polyester
LF10	Black*	100% Ramie
LF58	Gray	50% Cotton, 50% Polyester
LF62	Soft White	50% Cotton, 50% Polyester
BLACK-OUT LINERS		
BO03	Beige	100% Polyester
BO09	Espresso	100% Polyester
BO01	White	100% Polyester

Light-filtering liners are the same color on both sides. Black-out liners are off-white to the street.

*Black liners wider than 53" will be seamed.

SHADE STYLES

FABRIC SELECTION

The fabrics in this collection are made from natural materials, which are subject to variation in color, texture, and weave. Like any wood or bamboo product, fabrics may show natural color changes over time.

Natural fabrics are not ideal for rooms with excessive humidity like bathrooms. Shades installed in these environments may bow or twist over time.

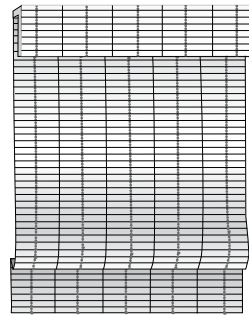

STANDARD ROMAN SHADE

Shade material is attached to the back of the head rail. Shade includes a 6" valance to conceal the components. When raised, the material rises from the bottom in flat folds.

Shades operated by cord loop will have controls in front of the shade.

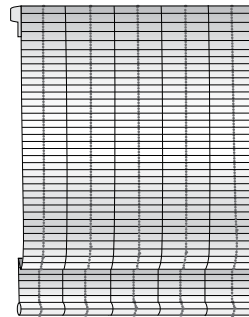

WATERFALL SHADE

Shade material is attached to the front of the head rail, without a valance. When raised, the material rises from the bottom in flat folds. Optional back valance is available upon request.

Shades operated by cord loop will have controls behind the shade.

VALANCE RETURNS

Outside mount shades are recommended to be ordered with valance returns. Returns for both outside and inside mount shades are available free of charge if requested at the time the order is placed.

Standard valance returns are made using the shade material. Valance returns can also be made using edge binding material upon request; this is a surcharge option.

Standard valance return height will be 1½" less than the valance height. This length will keep the rolled bottom of the valance from interfering with the return.

Optional short valance returns are also available. Short returns cover the end of the head rail and hide the components, keeping the stack of the raised shade away from the returns.

Custom valance return lengths are available to be ordered upon request.

All valance returns will be made with an L-shaped connector to attach to the back of the valance. This holds the returns in place and creates a clean, finished corner.

BOTTOM BAR

Clutch and motorized shades will be made with a round bottom bar. Cordless shades are made with a rectangular bottom bar.

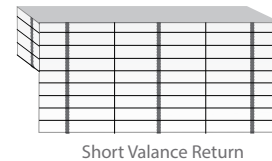
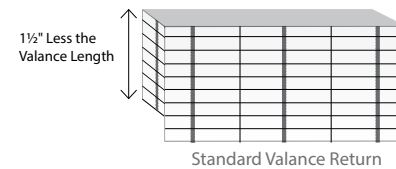

SHADE OPTIONS

LINERS

A liner can be ordered attached to the back of the shade or as a separate operable, movable liner (see Twin Shade below).

ATTACHED LINERS

Attached liners are available in light-filtering or black-out. They are secured to the back of the shade by stitches at each side of the liner. If a shade is lined, the valance will automatically be lined with the same material.

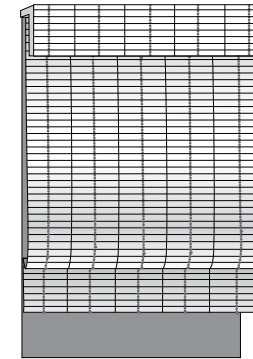

TWIN SHADE

A twin shade features two separate, independently operated shades on one head rail. The front shade can be either a standard or waterfall natural woven shade.

A separate liner shade is attached to the back of the head rail and both shades operate independently.

Outside mount twin shades will be made with a valance that is ¾" wider than the ordered shade width. This will allow the returns to fit behind the valance.

See Specifications for head rail sizes.

Not available as 3-on-1 headrail.

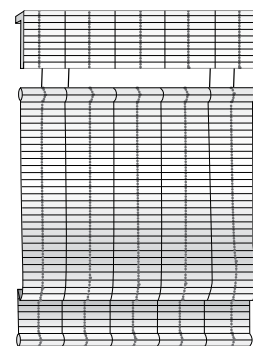

TOP-DOWN BOTTOM-UP SHADES

Top-down bottom-up (TDBU) shades can be raised from the bottom or lowered from the top. To conceal shade components, shades will be finished with a lined valance.

Outside mount TDBU shades will be made with a valance that is ¾" wider than the ordered shade width, allowing the returns to fit behind the valance.

TDBU shades are not available in waterfall style, as multiple shades on one head rail, or as twin shades.

Only available with cordless control.

MULTIPLE SHADES ON ONE HEAD RAIL

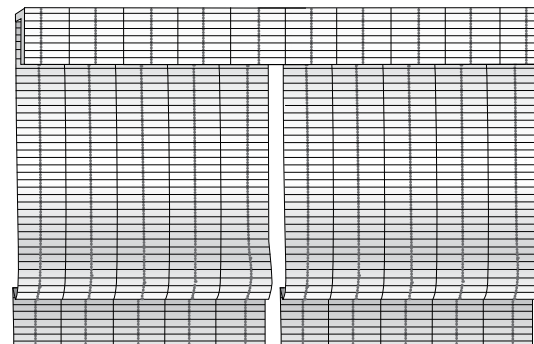

shown with two shades

Shades are available with 2-on-1 or 3-on-1 head rail. The maximum total width is 108" and the gap between shades will be no more than ½". The maximum width for a common valance is 96"; wider valances will be made in sections to match the individual shade widths.

Multiple shades on one head rail are available to be ordered with all control types except top-down bottom-up. Pay careful attention to make sure there are suitable locations for cord tensioners when specifying multiple shades on one head rail, particularly for the middle shade in 3-on-1 head rail units.

SHADE CONTROL OPTIONS

CORDLESS SHADES

Cordless shades operate with no lift cords on the front of the shade. The shade is lowered by pulling on the hem bar. A spring control system, located under the wooden head rail, holds the shade in place at any desired position.

Clear grips are added to the hem bar of cordless shades; one per shade up to 72" wide and two for wider shades.

Cordless shades are available up to 96" wide and 96" long and will be mounted on standard depth head rails (see Specifications for details).

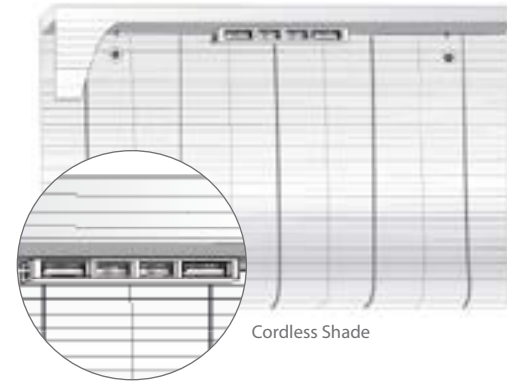

CLUTCH CONTROLS

Clutches provide an assisted lift for large or heavy shades and come standard with color-coordinated cord loops available in one foot increments from 2' to 6'. The factory will choose the length closest to 2/3 the shade height, unless otherwise requested. Nickel-plated bead chain loops are available as a surcharge option and can be made to custom lengths.

Compliant cord tensioners are provided with clutch control shades. Cord tensioners secure the cord loop to the wall or window. They must be installed for the shade to be compliant with safety regulations and to operate properly.

Standard shades ordered with a clutch come "clutch adjacent" to keep the stack of the raised shade from interfering with the loop. This means the shade fabric will be narrower than the ordered width on the control side, allowing the cord to hang to the side of the shade (see diagram). This may cause a light gap on black-out shades.

Waterfall shades ordered with clutch controls will have control loops behind the shade and are not available to be ordered as clutch adjacent.

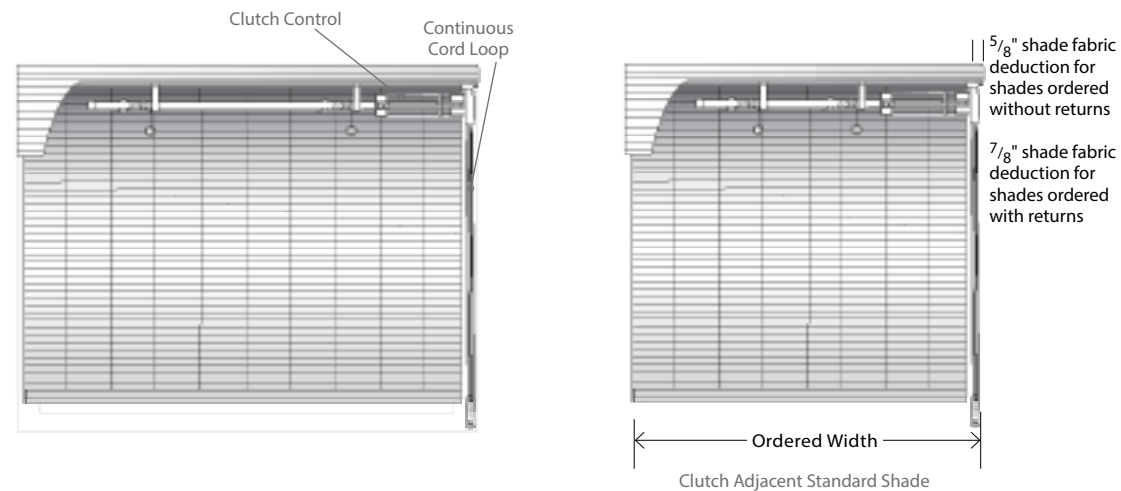

SHADE CONTROL OPTIONS

WAND CONTROL SHADES

Wand control motorized shades are powered by a rechargeable lithium-ion battery. The motor is controlled using a wand which hangs down to the side of the shade.

Waterfall shades are not available to be ordered with wand control.

Wands are available in 4 lengths: 24", 36", 48", and 60". Available colors include: white, beige, gray, bronze, and black.

Wand control shade motor batteries are recharged via a mini USB power adaptor which plugs into the end of the wand.

All wand control shades will be made with shade fabric narrower than the ordered width on the control side, allowing the wand to hang to the side of the shade. This may cause a light gap on black-out shades.

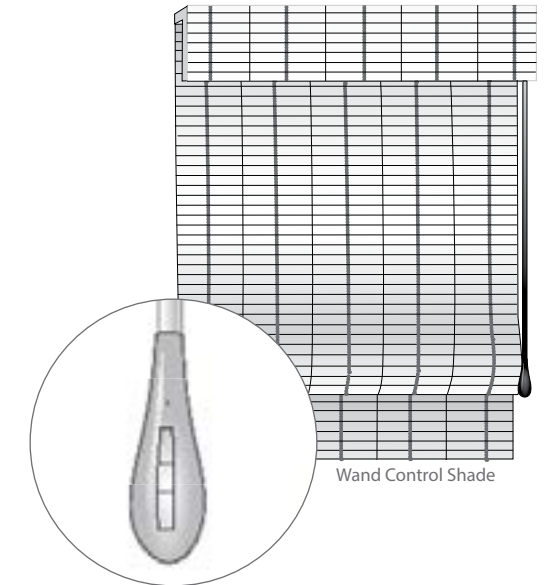

White, Beige, Gray, Bronze, or Black Wands

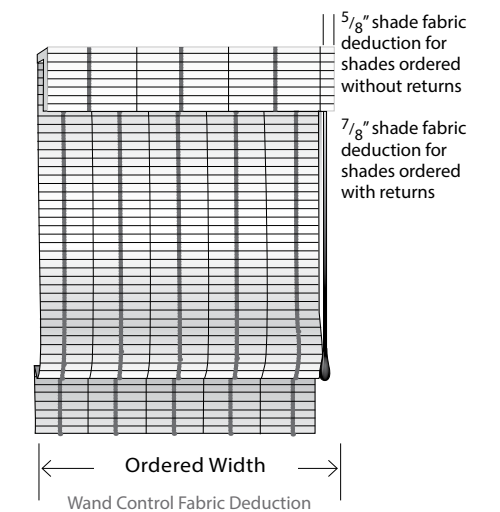

SHADE CONTROL OPTIONS

REMOTE CONTROL SHADES

Remote motors have rechargeable and hardwired options available which can be controlled with remotes, wall switches, or motor hubs.

See Specifications for minimum widths by motor type.

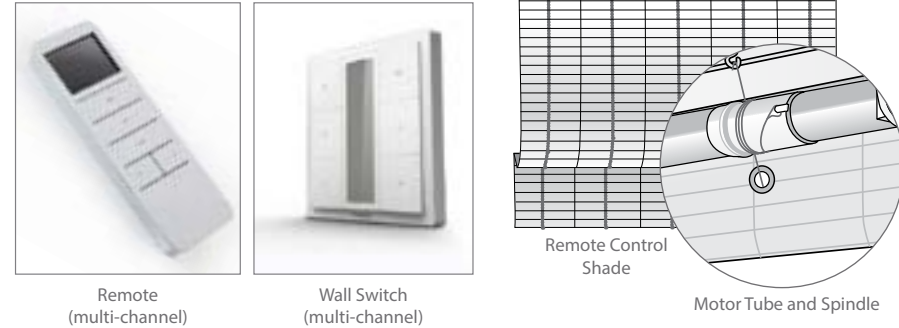

REMOTE MOTOR OPTIONS

	RECHARGEABLE LITHIUM ION	12 V DC HARDWIRED	12 V DC EXTERNAL POWER	100-240 AC HARDWIRED*
MOTOR TYPE	Standard Lift	Standard Lift	Standard Lift	Standard Lift
POWER SUPPLY	Internal	Hardwired	AA Battery Tube External LI Battery Pack	Hardwired AC wall plug not available through this collection
CHARGER	6'/16½' Micro-USB	-	6'/16½' Micro-USB Used to recharge LI Battery Pack	-
REMOTE	Single/15 Channel Remote Single/15 Channel Wall Switch	Single/15 Channel Remote Single/15 Channel Wall Switch	Single/15 Channel Remote Single/15 Channel Wall Switch	Single/15 Channel Remote Single/15 Channel Wall Switch
AUTOMATION	Pro Hub	Pro Hub	Pro Hub	Pro Hub

*Requires installation by an electrician.

PRO HUB

Connects through 2.4 GHz wifi or directly to router with ethernet cable.

Works with Connector+ App, Amazon Alexa, Control4, Google Home, IFTTT, RTI, Samsung Smart Things, and Siri Short Cuts.



Pro Hub

SHADE ADDITIONAL OPTIONS

LINED VALANCE (STANDARD SHADES)

Lined valances are included to conceal the head rail components where an open-weave pattern is selected.

All TDBU shades are made with lined valances as standard.

BACK VALANCE/INTERIOR VALANCE (WATERFALL SHADES)

Back valances for waterfall shades are available upon request and can be ordered in either the shade fabric or the liner fabric for lined shades. Back valances conceal the shade components from the back of the shade.

Interior valances come standard with waterfall shades that are unlined or that are ordered with a light-filtering liner. Interior valances block the outline of the shade components from showing on the front of the shade. Valances are 4" long and are made with black-out White (BO01) liner material. Because the valance is made with black-out fabric, the part of the shade in front of the interior valance will look darker than the rest of the shade when light is coming through.



EDGE BINDINGS

Edge binding is available for all patterns in the Walden Select Collection.

Edge binding is applied to the sides of both the shade and valance. It is not applied to the bottom of either.

Edge bindings are available in eight colors. Edge binding will show 5/8" on the face of the shade.

Some patterns are required to be ordered with edge binding, as noted in the Materials Reference table. Patterns that require edge binding have the cost of edge binding included in the base price of the shade and will have the warranty for frayed edges voided if ordered without edge binding.



Shade with Edge Binding

SHADE ADDITIONAL OPTIONS

CUT OUTS

Cut outs can be taken from either side of the shade. Exact dimensions and the locations of the cut outs are required.

Cut outs are not available with edge binding.

There may be limitations to what can be cut out, based upon the size and specifications of the shade. The factory will review all orders for cut outs and provide confirmation of each order within 24 hours.

HOLD DOWN BRACKETS AND SPACER BLOCKS

Hold down brackets are supplied upon request for all control types. Clutch and motorized shades ordered with hold down brackets will be made with a round bottom bar. Cordless shades with hold down brackets will be made with a rectangular bottom bar.

Spacer blocks measuring 3/8" are available upon request. Maximum of 2 spacer blocks per bracket recommended.

VALANCE ONLY

Valance Only is available for all fabrics. Valances can be specified in length up to 18" long and have a maximum width of 96". Valance returns will be made to the ordered length of the valance or can be requested in custom lengths.

Valances can be ordered attached to a head rail or loose. Available head rail depths for attached valances are: 1", 1½", 2½", 3 ¾", 4", or 5½".

Valances can be made with liners and edge binding for a surcharge. Please specify if valances should be lined or unlined or made with or without edge binding when placing your order.

SHADE SPECIFICATIONS

	MINIMUM WIDTH	MAXIMUM WIDTH	MINIMUM HEIGHT	MAXIMUM HEIGHT	IB DEDUCTION (width)	FLUSH IB DEPTH (top mount w/brkt)	MINIMUM IB DEPTH (top mount w/brkt)
CORDLESS	18"	96"	18"	96"	3/8"	2½"	¾"
CORDLESS TWIN	18"	96"	18"	96"	3/8"	4¾"	¾"
CLUTCH and LOOP	18"	96"	18"	108"	3/8"	3½"	¾"
TOP-DOWN BOTTOM-UP (TDBU)	20"	60"	18"	84"	3/8"	2½"	¾"
WAND CONTROL	23"	96"	18"	108"	3/8"	3½"	¾"
Remote Control Motors							
• STANDARD LITHIUM ION	23"	96"	18"	108"	3/8"	3½"	¾"
• STANDARD DC MOTOR	15"	96"	18"	108"	3/8"	3½"	¾"
• STANDARD AC MOTOR	20"	96"	18"	108"	3/8"	3½"	¾"
MULTIPLE SHADES ON ONE HR	-	108" total	-	-	-	-	-
COMMON VALANCE	-	96"	-	-	-	-	-
VALANCE ONLY	-	96"	-	18"	-	-	-

* Flush IB depth is head rail depth plus 1" when using standard bracket. Exact measurement will vary slightly based upon fabric thickness.

SHADE SPECIFICATIONS

BRACKET DIMENSIONS

Height: 1½"
Depth: 1¾"

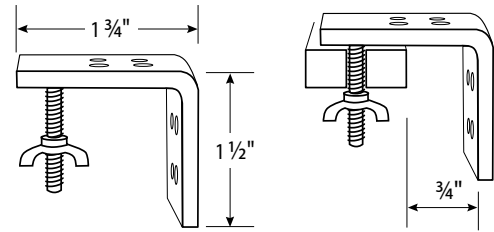

RING SPACING

First fold starts 3½" above the bottom bar, then rings are spaced 7" apart on back of the shade.

STACK HEIGHT

Approximately (all lengths): 8" to 10"

HEAD RAIL DIMENSIONS

Middle support brackets will be supplied for all shades over 41" wide.



CORDLESS HEAD RAIL
• Standard Shades
• Waterfall Shades
• TDBU

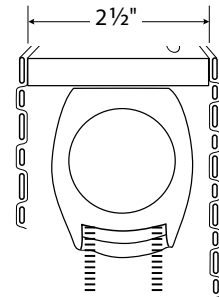

CLUTCH SHADE with Continuous Cord Loop

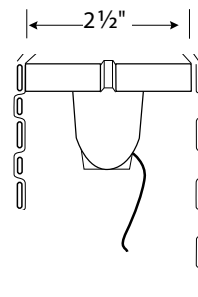

MOTORIZED HEAD RAIL REMOTE OR WAND CONTROL
• Standard Shades
• Waterfall Shades



TWIN SHADE W/CORDLESS

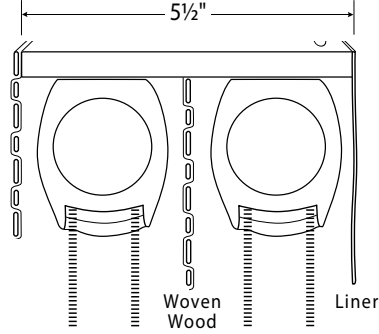

TWIN SHADE W/2 CLUTCHES
Controls Same Side (shown) or Opposite Sides

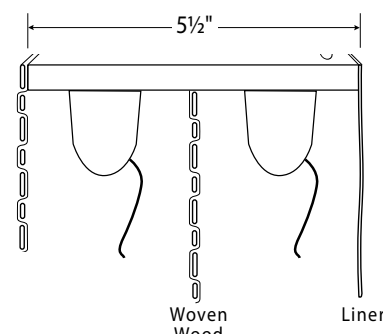

TWIN SHADE W/2 MOTORS
Controls Same Side (shown) or Opposite Sides

FOLDING DOORS

Check the Materials Reference table for patterns which are available to be made as folding doors.

Folding doors are ideal for large windows or doors and are suspended vertically from hangers, which slide smoothly inside an aluminum track. On each side of the door are wood bars with handles. The wood bars come in six colors and either a brown or white track. Wood bar and track colors are selected to coordinate with the chosen pattern.

Folding doors come in one of two configurations: one-way opening or center opening.

ONE-WAY OPENING

When open, the material stacks back either to the right or the left. Specify on the order form which side of the door the drapery will stack to.

NOTE: If you want the material to stack back completely clear of the window, for an unobstructed view when the door is open, allow for the width of the stack in the overall width of the door. See "Specifications" for more details.

CENTER OPENING (SPLIT DRAW)

The door is made from two panels, which are equal width and meet in the middle. They open to opposite sides of the window.

Each panel has a wood bar on both sides and the two middle bars have small, countersunk magnets which hold the two bars together tightly when the panels are in the closed position.

DRAPERY STYLE

Folding doors can be ordered "drapery style," which means no edge bars. Instead, they will have edge binding on all four sides of each panel for a softer look. Wide edge binding will be used on the top, bottom, and sides of the panel.

Drapery style folding doors can also be ordered as one-way or center opening.

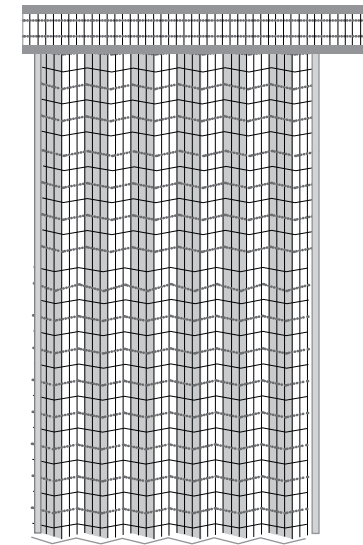

One-Way Left Stack shown with valance

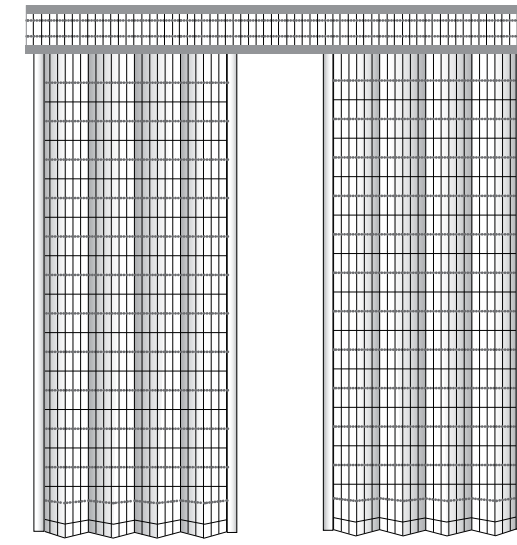

Center Opening – Split Draw shown with valance

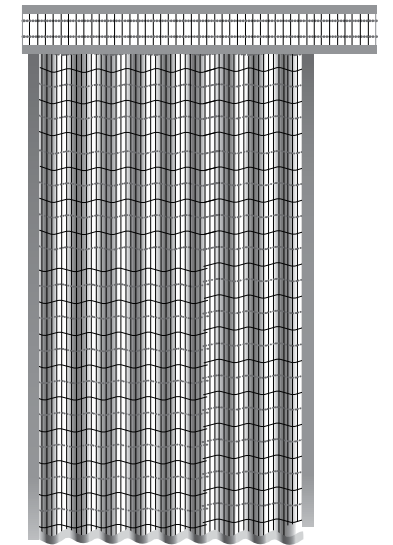

Drapery Style Left Stack shown with valance

FOLDING DOOR OPTIONS

FULLNESS

The standard folding door comes with 5% fullness, which means that it lies nearly flat when fully extended. Folding doors can be ordered with 20% fullness, which gives fuller folds; this is a surcharge option.

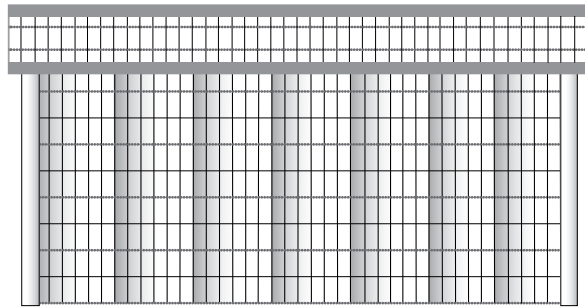

5% Fullness (fully extended)
shown with valance

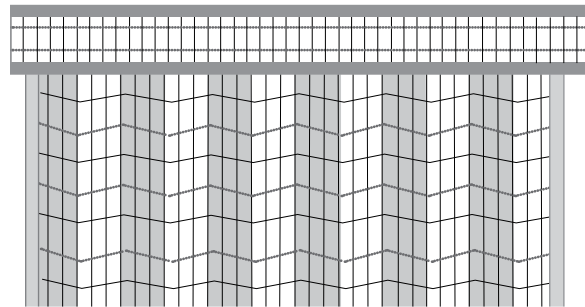

20% Fullness (fully extended)
shown with valance

LINERS

Linners are available in light-filtering or black-out. They are attached to the top of the folding door and are secured down both sides beneath the wood bars or edge binding.

VALANCE

Standard folding doors come with track and panels. Adding a valance provides a decorative touch. It also conceals the track and hangers and blocks any light gap between the track and the top of the door fabric.

The valance is 8" long and is mounted to a wooden board, 5 1/2" deep and 3/4" thick. The valance is attached to the front edge of the board by velcro.

The valance is oriented in the same direction as the door (vertically) and is edge-bound on the top and bottom. Narrow edge binding is standard on folding door valances.

For inside mount shades, the valance will cover the front of the valance board only. For outside mount shades, the valance will be made to wrap around both ends of the valance board.

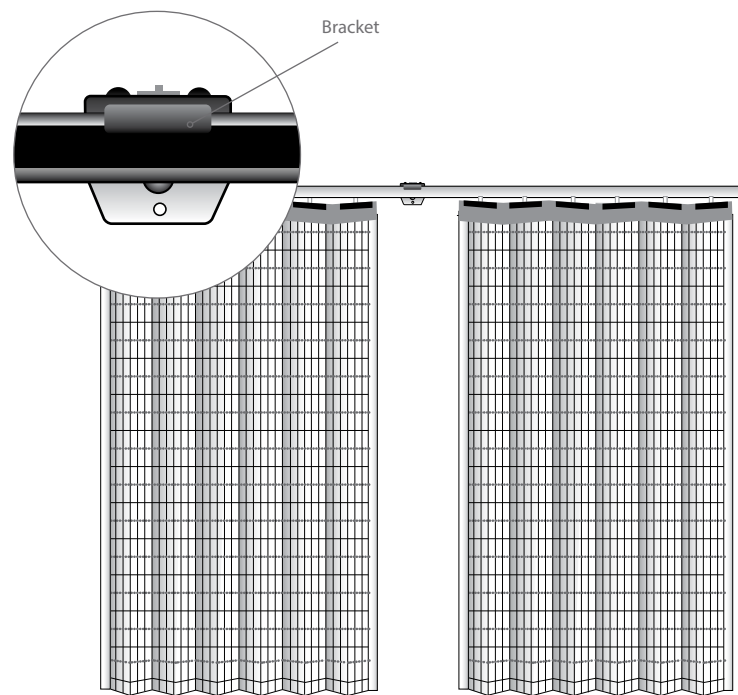

Center Opening - Split Draw
shown without valance

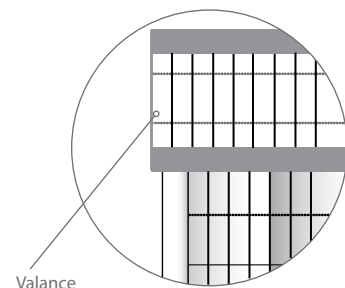

Valance

FOLDING DOOR SPECIFICATIONS

SIZE LIMITATIONS

Minimum Width: 24" Minimum Height: 24"
Maximum Width: 192" Maximum Height: 96"

Tracks and valance boards wider than 90" are spliced to avoid oversize freight charges.

DOORS WITHOUT A VALANCE

For doors without a valance, the height of the folding door is measured from the top of the track to the bottom of the fabric.

There is a gap of approximately 3/4" between the top of the track and the material. The factory will deduct this amount from the ordered length when they make the fabric panel.

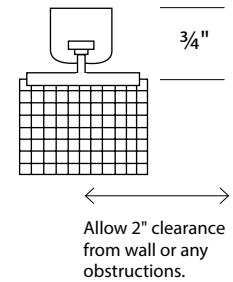

DOORS WITH A VALANCE

For doors with a valance, the height of the folding door is measured from the top of the valance board to the bottom of the fabric.

The valance board is 3/4" thick and there is 3/4" between the top of the track and the top of the material. The factory will deduct 1 1/2" from the ordered length when they make the fabric panel.

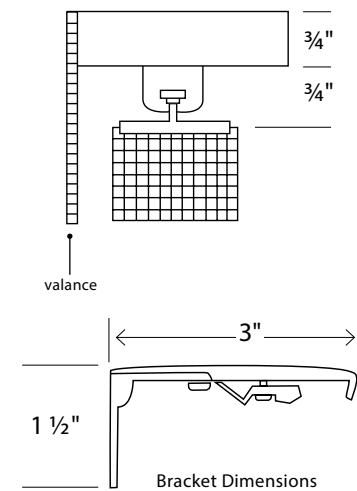

INSIDE MOUNT MEASUREMENTS

Minimum Inside Mount Depth: 2"

Check for any obstructions, such as trim or handles that may interfere with the opening and closing of the door.

Inside Mount Deductions:

Width: 1/4"
Height: 3/4"

No deductions are made to the width or height of outside mount doors.

STACKING CHART (5% FULLNESS)

WIDTH	STACK
36"	8 1/2"
42"	9"
48"	9 1/2"
60"	11"
72"	12"
84"	13"
96"	14"

Center opening (or split draw) folding doors will open into two equal stacks on each side. For example a 96" center opening will have two stacks, each the size of a 48" one-way opening door: 9 1/2".

20% fullness folding doors will stack approximately 1" wider for small doors and 1 1/2" wider for larger doors than same size at 5% fullness.

All stacking dimensions are approximate and will vary by pattern.

SLIDING PANELS

CONSTRUCTION AND OPERATION

- Sliding panels provide a clean, contemporary look for large windows and doors.
- Overlapping panels are suspended from hangers, which glide smoothly on an aluminum track and pass in front or behind each other, allowing panels to stack away from the window.
- Panels are attached to the track and are supplied with narrow edge binding to protect them from wear and tear and are custom sized, based on the ordered width and the number of panels.
- Sliding panels are operated with 48" wands; a center-opening sliding panel will have two wands.
- All patterns are able to be made as Sliding Panels.

NOTE: Because bamboo and natural materials can stretch or shrink, we recommend that panels are ordered with at least $\frac{3}{4}$ " clearance from the ground. When shipped from the factory, panels may be slightly different lengths (up to $\frac{1}{2}$ " from the ordered length). A shorter panel can be corrected by gently pulling on the bottom of the panel until it is the same length as longer panels.

ONE-WAY OPENING

- When open, all of panels stack back to either the right or the left. *Specify on the order to which side of the window the panels will stack.*
- The standard configuration is for the back panel to be stationary and all the other panels stack in front.
- Reverse stacking is available, with the front panel stationary. Free-floating panels are also available.
- NOTE: If you want the panels to stack completely away from the window for an unobstructed view, allow for the panel width in the overall width of the shade. See "Specifications" for more details.

CENTER OPENING (SPLIT DRAW)

- Must be made with an even number of panels. Panels stack to both sides.
- When made with four panels, the front left and back right panels are stationary.
- If made with six or eight panels, the back panels on both sides will be stationary and all other panels will stack in front on both sides. See Sliding Panel Configurations on page 21.
- Reverse stacking and free-floating panels are also available.



Wand Colors

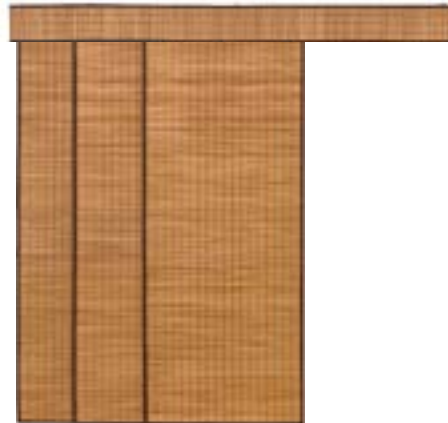

One-Way Left Stacked



Center Opening

SLIDING PANEL SPECIFICATIONS

LINERS

- Available in light-filtering or black-out.
- Sewn under the edge binding on all four panel sides.

EDGE BINDING

- Panels will come with narrow (1") edge binding as standard, which means that $\frac{1}{2}$ " is visible on the face of the panels.

VALANCE

- Valances are 8" long and attached to the front and sides of the track by velcro. If a valance is part of the original sliding panel order, the velcro for the valance will be riveted to the front of the track to ensure a lasting bond.
- Valances are cut up the roll, so they wrap around the ends of the track. This means the valance material is railroaded and will be oriented differently to the panels. For inside mount sliding panels, the valance will cover the front of the track only. For outside mount sliding panels the valance will be made to wrap around both ends of the track.
- When ordered separately, both velcro halves are provided, but the bond between the velcro and the track will not be as durable.

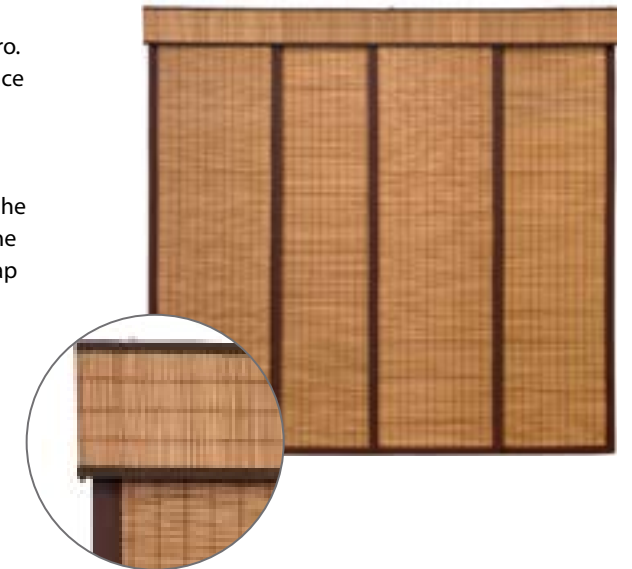

SLIDING PANEL SPECIFICATIONS

SIZE LIMITATIONS

Minimum Width: 48" Minimum Height: 24"
 Maximum Width: 144" Maximum Height: 120"

Tracks wider than 90" are spliced to avoid oversize freight charges.

STANDARD PANEL CONFIGURATIONS

WIDTH	TYPE OF OPENING	# OF PANELS	TRACK TYPE
48" - 84"	One-Way	3 Panels	3 Channel
	Center Opening	4 Panels	2 Channel
84 1/4" - 120"	One-Way	4 Panels	4 Channel
	Center Opening	4 Panels	2 Channel
120 1/4" - 144"	One-Way	5 Panels	5 Channel
	Center Opening	6 Panels	4 Channel

TYPICAL PANEL SIZES (OUTSIDE MOUNT SHADE)

WIDTH	ONE-WAY DRAW		CENTER OPENING	
60"	3 panels	21 5/8"	4 panels	16 7/8"
72"	3 panels	25 5/8"	4 panels	19 7/8"
84"	3 panels	29 5/8"	4 panels	22 7/8"
96"	4 panels	25 7/8"	4 panels	25 7/8"
108"	4 panels	28 7/8"	4 panels	28 7/8"
120"	4 panels	31 7/8"	4 panels	31 7/8"
132"	5 panels	28 3/8"	6 panels	24 1/8"
144"	5 panels	30 3/4"	6 panels	26 1/4"

PANEL SIZE CALCULATIONS

To calculate the approximate panel width, use the ordered width and the number of panels.

Deduct one from the number of panels and multiply this number by 2.5. Then add this number to the ordered width and divide the resulting number by the number of panels.

For example: For a sliding panel order with an 80" width and 5 panels, each panel will be approximately 18" wide.

$$5 \text{ (panels)} - 1 = 4$$

$$4 \times 2.5 = 10"$$

$$80" \text{ (ordered width)} + 10" = 90"$$

$$90" / 5 \text{ (panels)} = 18" \text{ panel width}$$

TRACK DIMENSIONS

TRACK DEPTHS	
3 Channel	2"
4 Channel	2 3/4"
5 Channel	3 3/8"

The distance from the top of the track to the top of the panels is 1". The factory will take account of this distance when calculating the panel length.

MOUNTING DEPTHS

	3 TRACK	4 TRACK	5 TRACK
Minimum IB	2"	2 3/4"	3 3/8"
Flush IB	2 1/2"	3 1/4"	3 7/8"

Wall or Face Mount: 1 3/4" flat mounting surface required. (Using L Bracket)

INSIDE MOUNT DEDUCTIONS

IB Deduction (Width): 1/4"
 IB Deduction (Height): 1/2"

DISTANCE FROM THE WALL TO THE BACK OF THE TRACK (CLEARANCE)

	3-CHANNEL TRACK	4-CHANNEL TRACK	5-CHANNEL TRACK
Standard Bracket (2 7/8")	1 3/8"	1 1/4"	3/4"
Large Bracket (4 1/4")	2 1/2"	2 3/8"	1 7/8"

Adding an extension bracket will provide an extra 2 7/8" of clearance from the wall.

Add the track depth to the clearance to calculate the total projection into the room.

SLIDING PANEL BRACKET

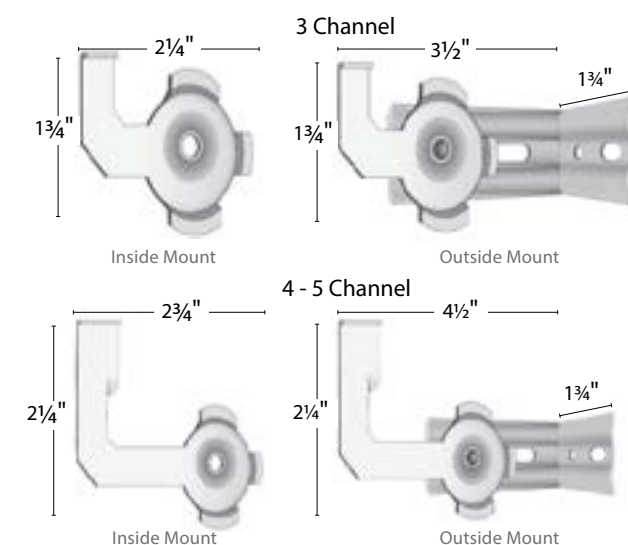

SLIDING PANEL CONFIGURATIONS

GENERAL OPERATION

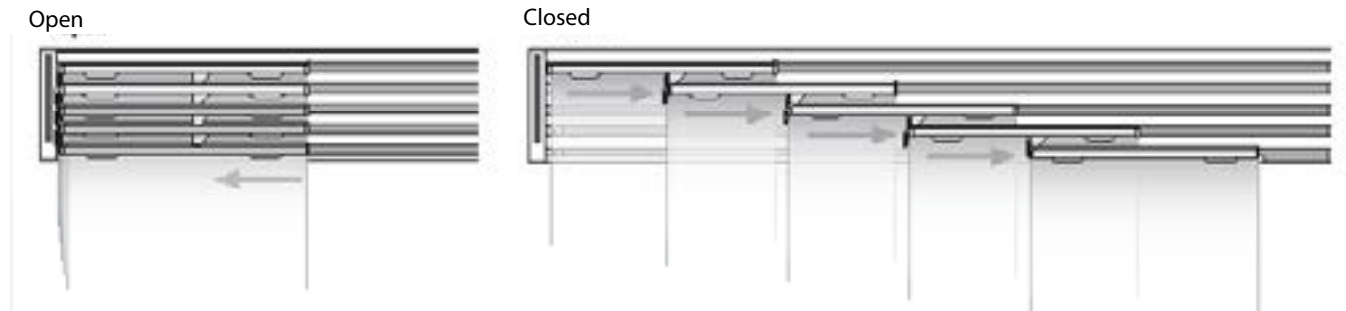

ONE WAY CONFIGURATIONS

3 Channel Track / 3 Panels / One Way Left



3 Channel Track / 3 Panels / One Way Right



4 Channel Track / 4 Panels / One Way Left



4 Channel Track / 4 Panels / One Way Right

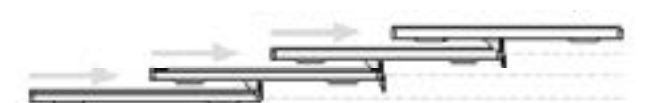

5 Channel Track / 5 Panels / One Way Left



5 Channel Track / 5 Panels / One Way Right

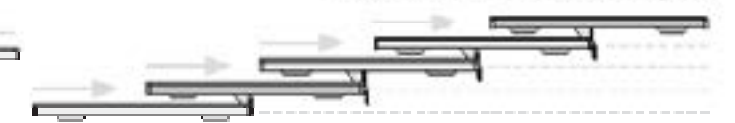

CENTER SPLIT CONFIGURATIONS

2 Channel Track / 4 Panels / Center Split stationary front left and back right



4 Channel Track / 6 Panels / Center Split



5 Channel Track / 8 Panels / Center Split



SHADE PRICING | GROUP A – C

Pricing includes Cordless and Clutch shades.

		WIDTH									
		24"	30"	36"	42"	48"	60"	72"	84"	96"	
PRICE GROUP A Pudong	LENGTH	36"	348	355	401	432	464	581	632	734	786
		48"	378	414	448	489	525	662	719	839	904
		54"	394	448	473	512	560	703	775	889	966
		60"	408	460	500	539	578	737	832	939	1,029
		66"	423	473	525	566	612	816	880	1,015	1,115
		72"	437	492	550	594	641	844	918	1,092	1,199
		78"	457	516	575	630	686	886	979	1,143	1,262
		84"	475	539	602	662	732	927	1,022	1,199	1,337
		96"	507	580	654	722	790	1,031	1,154	1,344	1,501
		108"	553	636	718	795	870	1,136	1,274	1,485	1,662
18" VALANCE ONLY		18"	172	178	215	240	266	325	365	424	466

		WIDTH									
		24"	30"	36"	42"	48"	60"	72"	84"	96"	
PRICE GROUP B Cala Malvern Osaka	LENGTH	36"	392	419	467	496	525	632	694	812	895
		48"	446	492	539	578	618	726	796	939	1,063
		54"	458	512	564	609	652	771	848	1,002	1,126
		60"	475	532	589	637	684	816	900	1,063	1,188
		66"	492	555	616	668	720	859	954	1,120	1,249
		72"	510	577	643	698	754	900	1,007	1,177	1,308
		78"	526	598	670	730	790	945	1,059	1,233	1,372
		84"	543	620	695	759	824	989	1,111	1,288	1,435
		96"	580	688	747	820	892	1,115	1,261	1,455	1,614
		108"	636	730	822	904	985	1,231	1,396	1,610	1,788
18" VALANCE ONLY		18"	208	229	269	291	314	365	416	488	554

		WIDTH									
		24"	30"	36"	42"	48"	60"	72"	84"	96"	
PRICE GROUP C Lou Metro Terra Umbria	LENGTH	36"	433	473	516	541	589	741	836	1,009	1,133
		48"	466	519	573	607	641	830	939	1,129	1,297
		54"	487	546	605	645	682	868	1,013	1,211	1,358
		60"	510	573	634	679	732	929	1,059	1,262	1,446
		66"	534	598	662	709	775	989	1,134	1,347	1,534
		72"	553	623	691	741	811	1,061	1,217	1,444	1,641
		78"	577	650	723	788	870	1,113	1,276	1,516	1,727
		84"	596	675	754	834	913	1,163	1,337	1,585	1,811
		96"	637	727	813	900	1,002	1,297	1,510	1,772	2,010
		108"	702	802	897	997	1,112	1,439	1,677	1,967	2,235
18" VALANCE ONLY		18"	241	273	307	327	365	453	529	644	743

SHADE PRICING | GROUPS D – F

Pricing includes Cordless and Clutch shades.

		WIDTH									
		24"	30"	36"	42"	48"	60"	72"	84"	96"	
PRICE GROUP D Antilles Camden Chelsea Halifax Harbor Montana Nantucket Parchment Portland Sonoma Tortola	LENGTH	36"	482	500	546	575	602	771	871	1,049	1,201
		48"	496	544	611	648	686	877	998	1,195	1,364
		54"	519	589	659	693	727	927	1,061	1,267	1,448
		60"	541	625	689	736	766	977	1,124	1,340	1,530
		66"	564	645	723	764	807	1,091	1,229	1,446	1,650
		72"	589	662	738	795	850	1,138	1,308	1,551	1,766
		78"	607	689	770	889	913	1,192	1,372	1,628	1,856
		84"	634	718	802	932	976	1,247	1,437	1,700	1,947
		96"	682	777	870	942	1,060	1,415	1,634	1,936	2,208
		108"	750	858	963	1,044	1,174	1,569	1,816	2,153	2,459
18" VALANCE ONLY		18"	280	294	331	354	376	478	558	676	798

		WIDTH									
		24"	30"	36"	42"	48"	60"	72"	84"	96"	
PRICE GROUP E Alisia Andros Como Fay Peri Selene	LENGTH	36"	564	586	640	674	706	894	1,009	1,206	1,379
		48"	590	645	721	764	809	1,020	1,159	1,378	1,568
		54"	621	700	780	819	860	1,080	1,233	1,462	1,666
		60"	650	744	818	871	908	1,141	1,307	1,548	1,761
		66"	680	771	861	908	958	1,272	1,428	1,669	1,898
		72"	713	796	882	946	1,011	1,328	1,520	1,790	2,031
		78"	738	830	922	1,055	1,085	1,392	1,596	1,880	2,135
		84"	773	867	963	1,109	1,159	1,458	1,672	1,964	2,241
		96"	836	944	1,048	1,130	1,262	1,654	1,899	2,234	2,538
		108"	921	1,042	1,160	1,252	1,398	1,833	2,110	2,482	2,826
18" VALANCE ONLY		18"	346	363	407	433	459	575	668	802	940

		WIDTH									
		24"	30"	36"	42"	48"	60"	72"	84"	96"	
PRICE GROUP F Soft Jute	LENGTH	36"	631	692	760	799	875	1,087	1,234	1,485	1,675
		48"	690	772	856	909	963	1,231	1,400	1,675	1,933
		54"	727	818	910	970	1,030	1,292	1,515	1,804	2,029
		60"	767	863	958	1,026	1,110	1,389	1,590	1,884	2,166
		66"	807	906	1,006	1,077	1,180	1,485	1,708	2,018	2,302
		72"	842	948	1,054	1,131	1,239	1,598	1,836	2,168	2,468
		78"	882	994	1,107	1,206	1,332	1,681	1,930	2,281	2,602
		84"	917	1,036	1,158	1,282	1,402	1,761	2,026	2,390	2,734
		96"	989	1,126	1,257	1,392	1,546	1,972	2,297	2,680	3,042
		108"	1,095	1,249	1,393	1,547	1,720	2,195	2,557	2,983	3,392
18" VALANCE ONLY		18"	399	448	502	534	594	730	847	1,025	1,178

SHADE SURCHARGE OPTION PRICING

Add any applicable surcharges below to the retail price of the basic shade.

WIDTH

LIGHT-FILTERING LINERS Light-filtering liners are the same color on both sides. Beige Black Gray Soft White	LENGTH	24"	30"	36"	42"	48"	60"	72"	84"	96"
		36"	\$43	\$55	\$65	\$75	\$87	\$108	\$130	\$152
48"	\$57	\$70	\$84	\$98	\$111	\$140	\$168	\$195	\$224	
54"	\$62	\$77	\$93	\$108	\$125	\$156	\$186	\$217	\$248	
60"	\$69	\$86	\$103	\$120	\$137	\$171	\$205	\$239	\$273	
66"	\$75	\$93	\$111	\$130	\$149	\$186	\$224	\$260	\$297	
72"	\$81	\$101	\$122	\$142	\$161	\$202	\$241	\$282	\$323	
78"	\$87	\$108	\$130	\$152	\$174	\$217	\$260	\$304	\$346	
84"	\$93	\$116	\$140	\$162	\$186	\$232	\$278	\$324	\$372	
96"	\$106	\$132	\$159	\$185	\$210	\$263	\$316	\$369	\$421	
108"	\$118	\$147	\$176	\$207	\$236	\$294	\$353	\$411	\$471	

WIDTH

BLACK-OUT LINERS Black-out liners are off white to the street. Beige White Espresso	LENGTH	24"	30"	36"	42"	48"	60"	72"	84"	96"
		36"	\$47	\$57	\$69	\$81	\$91	\$115	\$137	\$159
48"	\$58	\$74	\$87	\$103	\$118	\$147	\$176	\$205	\$234	
54"	\$65	\$82	\$98	\$115	\$130	\$162	\$195	\$227	\$261	
60"	\$72	\$89	\$108	\$125	\$144	\$179	\$215	\$251	\$287	
66"	\$79	\$98	\$118	\$137	\$157	\$195	\$234	\$273	\$312	
72"	\$86	\$106	\$127	\$149	\$169	\$212	\$254	\$297	\$338	
78"	\$91	\$115	\$137	\$159	\$183	\$227	\$273	\$319	\$365	
84"	\$98	\$123	\$147	\$171	\$195	\$244	\$294	\$341	\$391	
96"	\$111	\$139	\$166	\$193	\$222	\$277	\$333	\$387	\$442	
108"	\$123	\$156	\$186	\$217	\$248	\$309	\$370	\$433	\$495	

WIDTH

EDGE BINDING* Camel Navy Olive Onyx Pearl Stone Titanium Wheat	LENGTH	24"	30"	36"	42"	48"	60"	72"	84"	96"
		36"	62	65	69	72	75	82	89	96
48"	75	79	82	86	89	96	103	110	116	
54"	82	86	89	93	96	103	110	116	123	
60"	89	93	96	99	103	110	116	123	130	
66"	96	99	103	106	110	116	123	130	137	
72"	103	106	110	113	116	123	130	137	144	
78"	110	113	116	120	123	130	137	144	150	
84"	116	120	123	127	130	137	144	150	157	
96"	130	133	137	140	144	150	157	164	171	
108"	144	147	150	154	157	164	171	178	185	

*Edge Binding Surcharge does not apply for fabrics that require edge binding.

VALANCE ONLY LINER SURCHARGE: \$49

VALANCE ONLY EDGE BINDING SURCHARGE*: \$29

*Edge Binding Surcharge does not apply for fabrics that require edge binding.

SHADE SURCHARGE OPTION PRICING

STYLE OPTIONS

MULTIPLE SHADES ON ONE HEAD RAIL
Add surcharge to price of two/three individual shades:

- 2-ON-1: \$66 surcharge
- 3-ON-1: \$81 surcharge

TWIN SHADE (MOVABLE LINER): \$386 surcharge
Add surcharge to cost of shade with liner.

TDBU: \$180

FABRIC VALANCE RETURNS: \$50
Made of edge binding material.

STAINLESS STEEL CHAIN: \$47

CUT OUTS: \$50 each cut out

WAND CONTROL SHADES

WAND CONTROL MOTOR: \$294 (includes Wand)

WAND CONTROL BATTERY CHARGER

Chargers are not included with motorized shades; please identify desired quantity when placing order.

USB WAND CHARGER: \$81



White, Beige, Gray, Bronze, or Black Wands

REMOTE CONTROL SHADES

Chargers are not included with motorized shades; please identify desired quantity when placing order.

REMOTE CONTROL MOTOR (LI, DC, AC STYLES): \$437

REMOTES

SINGLE-CHANNEL REMOTE: \$89

MULTI-CHANNEL REMOTE: \$113

WALL SWITCHES

SINGLE-CHANNEL SWITCH: \$158

MULTI-CHANNEL SWITCH: \$20

PRO HUB: \$585



Single-Channel Remote



Multi-Channel Remote



Single-Channel Switch



Multi-Channel Switch



Pro Hub

REMOTE CONTROL CHARGERS AND BATTERIES

Chargers are not included with motorized shades; please identify desired quantity when placing order.

USB REMOTE MOTOR CHARGER (6' CABLE): \$81

USB REMOTE MOTOR CHARGER (16½' CABLE): \$102

RECHARGEABLE LITHIUM ION BATTERY PACK (POWERS DC MOTOR): \$150

FOLDING DOOR PRICING – ONE WAY OPENING

All tracks and valance boards over 90" wide will be spliced to avoid oversize freight charges.

5% FULLNESS

		WIDTH												
		48"	60"	72"	84"	96"	120"	132"	144"	156"	168"	180"	192"	
PRICE GROUP A Pudong	LENGTH	48"	576	679	777	899	1,018	1,246	1,360	1,475	1,590	1,705	1,820	1,934
		60"	643	760	873	1,009	1,143	1,402	1,531	1,661	1,790	1,920	2,049	2,179
		72"	709	841	969	1,119	1,268	1,558	1,702	1,847	1,991	2,135	2,279	2,423
		84"	776	922	1,064	1,230	1,393	1,715	1,876	2,037	2,198	2,359	2,521	2,682
		96"	842	1,003	1,160	1,340	1,518	1,871	2,049	2,227	2,406	2,584	2,762	2,941
VALANCE		173	178	227	232	287	357	382	406	430	455	479	504	

		WIDTH												
		48"	60"	72"	84"	96"	120"	132"	144"	156"	168"	180"	192"	
PRICE GROUP B Cala Malvern Osaka	LENGTH	48"	613	725	832	963	1,091	1,337	1,459	1,582	1,704	1,826	1,948	2,070
		60"	689	818	942	1,089	1,235	1,516	1,658	1,800	1,941	2,083	2,225	2,366
		72"	764	910	1,051	1,216	1,378	1,696	1,854	2,013	2,172	2,331	2,489	2,648
		84"	840	1,003	1,161	1,342	1,521	1,875	2,051	2,227	2,402	2,578	2,754	2,930
		96"	916	1,095	1,270	1,468	1,665	2,054	2,249	2,445	2,640	2,836	3,031	3,226
VALANCE		192	200	252	260	323	403	433	462	491	521	550	579	

		WIDTH												
		48"	60"	72"	84"	96"	120"	132"	144"	156"	168"	180"	192"	
PRICE GROUP C Lou Metro Umbria	LENGTH	48"	676	804	927	1,073	1,217	1,495	1,629	1,763	1,898	2,032	2,166	2,301
		60"	767	916	1,060	1,227	1,392	1,713	1,872	2,031	2,189	2,348	2,507	2,666
		72"	859	1,028	1,193	1,381	1,567	1,932	2,115	2,298	2,481	2,664	2,848	3,031
		84"	950	1,140	1,326	1,534	1,741	2,150	2,353	2,555	2,758	2,961	3,164	3,366
		96"	1,041	1,253	1,459	1,689	1,916	2,369	2,596	2,823	3,050	3,277	3,504	3,731
VALANCE		222	235	293	306	380	450	484	518	552	587	621	655	

FOLDING DOOR SURCHARGE PRICING

All tracks and valance boards over 90" wide will be spliced to avoid oversize freight charges.

5% FULLNESS

		WIDTH												
		48"	60"	72"	84"	96"	120"	132"	144"	156"	168"	180"	192"	
PRICE GROUP D Chelsea	LENGTH	48"	800	952	1,097	1,270	1,441	1,770	1,929	2,088	2,247	2,407	2,566	2,725
		60"	909	1,084	1,255	1,453	1,648	2,029	2,217	2,405	2,593	2,781	2,969	3,157
		72"	1,017	1,217	1,413	1,635	1,855	2,288	2,505	2,722	2,939	3,156	3,372	3,589
		84"	1,125	1,350	1,570	1,817	2,062	2,546	2,786	3,027	3,267	3,507	3,747	3,987
		96"	1,233	1,483	1,728	2,000	2,269	2,805	3,074	3,343	3,612	3,881	4,150	4,419
VALANCE		263	279	347	363	450	533	573	614	654	695	735	776	

		WIDTH												
		48"	60"	72"	84"	96"	120"	132"	144"	156"	168"	180"	192"	
PRICE GROUP E Alisia Andros Fay	LENGTH	48"	957	1,138	1,312	1,519	1,724	2,117	2,307	2,498	2,688	2,878	3,068	3,259
		60"	1,087	1,297	1,501	1,737	1,971	2,426	2,651	2,876	3,101	3,326	3,551	3,776
		72"	1,216	1,456	1,689	1,955	2,219	2,736	2,995	3,255	3,514	3,774	4,033	4,293
		84"	1,346	1,615	1,878	2,173	2,467	3,045	3,332	3,620	3,907	4,194	4,481	4,768
		96"	1,475	1,774	2,066	2,392	2,714	3,355	3,677	3,998	4,320	4,642	4,964	5,285
VALANCE		315	333	415	433	538	637	686	734	782	831	879	928	

		WIDTH												
		48"	60"	72"	84"	96"	120"	132"	144"	156"	168"	180"	192"	
LIGHT-FILTERING LINERS Light-filtering liners are the same color on both sides. Beige Black Gray Soft White	LENGTH	48"	184	218	250	289	328	402	438	475	511	548	585	621
		60"	207	246	283	327	371	455	498	540	583	625	668	710
		72"	230	273	316	365	414	509	557	604	652	700	747	795
		84"	252	301	349	403	457	563	616	668	721	774	827	879
		96"	275	329	381	441	500	617	675	734	792	851	910	968
VALANCE*		58	60	76	78	97	121	130	139	148	157	165	174	

*If folding door is ordered with a liner, there will be no additional lined valance surcharge.

		WIDTH												
		48"	60"	72"	84"	96"	120"	132"	144"	156"	168"	180"	192"	
BLACK-OUT LINERS Black-out liners are off white to the street. Beige Espresso White	LENGTH	48"	246	290	333	385	437	535	584	633	682	731	779	828
		60"	276	327	377	436	494	607	664	720	777	834	890	947
		72"	306	364	421	487	551	679	742	806	869	933	996	1,060
		84"	336	401	465	537	609	750	821	891	961	1,032	1,102	1,172
		96"	367	438	508	588	666	822	900	978	1,056	1,135	1,213	1,291
VALANCE*		77	80	101	104	129	162	173	185	197	209	220	232	

*If folding door is ordered with a liner, there will be no additional lined valance surcharge.

20% FULLNESS: ADD 20%
SPLIT DRAW (CENTER-OPENING): \$236

NET FREIGHT SURCHARGE:
UP TO 93" LONG: \$40
OVER 93" LONG: \$100

SLIDING PANEL PRICING – PRICE GROUPS A-C

All tracks and valance boards over 90" wide will be spliced to avoid oversize freight charges.

		WIDTH												
		60"	72"	84"	96"	108"	120"	132"	144"	156"	168"	180"	192"	
PRICE GROUP A Pudong	LENGTH	60"	994	1,119	1,254	1,419	1,544	1,679	1,812	1,930	2,091	2,252	2,412	2,573
		72"	1,076	1,214	1,361	1,545	1,683	1,831	1,982	2,112	2,288	2,464	2,640	2,816
		84"	1,158	1,308	1,469	1,672	1,822	1,983	2,152	2,295	2,486	2,677	2,868	3,060
		96"	1,240	1,403	1,576	1,798	1,961	2,135	2,322	2,477	2,684	2,890	3,096	3,303
		108"	1,395	1,578	1,773	2,023	2,207	2,402	2,612	2,787	3,019	3,251	3,483	3,716
		120"	1,550	1,754	1,970	2,248	2,452	2,668	2,902	3,096	3,354	3,612	3,870	4,128
VALANCE		72	86	100	113	129	142	156	171	186	200	214	228	

		WIDTH												
		60"	72"	84"	96"	108"	120"	132"	144"	156"	168"	180"	192"	
PRICE GROUP B Cala Malvern Osaka	LENGTH	60"	1,016	1,145	1,284	1,454	1,583	1,722	1,859	1,980	2,145	2,310	2,475	2,640
		72"	1,102	1,245	1,397	1,587	1,730	1,882	2,038	2,173	2,354	2,535	2,716	2,897
		84"	1,189	1,345	1,511	1,720	1,876	2,042	2,217	2,365	2,562	2,759	2,957	3,154
		96"	1,275	1,445	1,624	1,854	2,023	2,203	2,396	2,558	2,771	2,984	3,197	3,410
		108"	1,434	1,625	1,827	2,085	2,276	2,478	2,695	2,877	3,117	3,357	3,597	3,836
		120"	1,594	1,806	2,030	2,317	2,529	2,753	2,995	3,197	3,464	3,730	3,996	4,263
VALANCE		74	90	105	119	135	150	164	179	194	209	224	239	

		WIDTH												
		60"	72"	84"	96"	108"	120"	132"	144"	156"	168"	180"	192"	
PRICE GROUP C Lou Metro Terra Umbria	LENGTH	60"	1,036	1,168	1,310	1,485	1,617	1,759	1,900	2,025	2,194	2,362	2,531	2,700
		72"	1,126	1,272	1,429	1,624	1,771	1,927	2,087	2,226	2,412	2,597	2,783	2,968
		84"	1,216	1,377	1,548	1,763	1,924	2,095	2,275	2,428	2,630	2,833	3,035	3,237
		96"	1,306	1,482	1,667	1,903	2,078	2,263	2,462	2,629	2,848	3,068	3,287	3,506
		108"	1,470	1,667	1,875	2,141	2,338	2,546	2,769	2,958	3,204	3,451	3,697	3,944
		120"	1,633	1,852	2,083	2,378	2,597	2,829	3,077	3,287	3,560	3,834	4,108	4,382
VALANCE		78	94	109	125	140	156	171	187	203	218	234	249	

SLIDING PANEL PRICING – PRICE GROUPS D-F

All tracks and valance boards over 90" wide will be spliced to avoid oversize freight charges.

		WIDTH												
		60"	72"	84"	96"	108"	120"	132"	144"	156"	168"	180"	192"	
PRICE GROUP D Antilles Camden Chelsea Halifax Harbor Montana Nantucket Parchment Portland Sonoma Tortola	LENGTH	60"	1,102	1,246	1,400	1,589	1,733	1,887	2,039	2,176	2,357	2,539	2,720	2,901
		72"	1,205	1,366	1,537	1,749	1,910	2,080	2,254	2,408	2,608	2,809	3,010	3,210
		84"	1,309	1,486	1,674	1,909	2,086	2,274	2,470	2,639	2,859	3,079	3,299	3,519
		96"	1,412	1,606	1,810	2,069	2,263	2,467	2,685	2,871	3,110	3,349	3,589	3,828
		108"	1,589	1,807	2,037	2,328	2,546	2,775	3,020	3,230	3,499	3,768	4,037	4,306
		120"	1,765	2,008	2,263	2,586	2,829	3,084	3,356	3,589	3,888	4,187	4,486	4,785
VALANCE		88	105	123	140	158	175	193	210	228	245	263	280	

		WIDTH												
		60"	72"	84"	96"	108"	120"	132"	144"	156"	168"	180"	192"	
PRICE GROUP E Alisia Andros Como Fay Peri Selene	LENGTH	60"	1,243	1,405	1,579	1,792	1,954	2,128	2,300	2,455	2,659	2,864	3,068	3,273
		72"	1,360	1,541	1,733	1,973	2,154	2,347	2,543	2,716	2,942	3,168	3,395	3,621
		84"	1,476	1,676	1,888	2,153	2,353	2,565	2,786	2,977	3,225	3,473	3,721	3,969
		96"	1,593	1,812	2,042	2,334	2,553	2,783	3,028	3,238	3,508	3,778	4,048	4,318
		108"	1,792	2,038	2,297	2,626	2,872	3,131	3,407	3,643	3,947	4,250	4,554	4,857
		120"	1,991	2,265	2,552	2,917	3,191	3,478	3,785	4,048	4,385	4,723	5,060	5,397
VALANCE		99	119	139	159	178	198	218	238	257	277	297	317	

		WIDTH												
		60"	72"	84"	96"	108"	120"	132"	144"	156"	168"	180"	192"	
PRICE GROUP F Soft Jute	LENGTH	60"	1,677	1,897	2,132	2,419	2,638	2,873	3,105	3,313	3,590	3,866	4,142	4,418
		72"	1,835	2,080	2,340	2,663	2,908	3,168	3,433	3,666	3,972	4,277	4,583	4,888
		84"	1,993	2,263	2,548	2,907	3,177	3,462	3,760	4,019	4,354	4,689	5,024	5,358
		96"	2,151	2,446	2,756	3,151	3,446	3,757	4,088	4,372	4,736	5,100	5,465	5,829
		108"	2,419	2,752	3,101	3,544	3,877	4,226	4,599	4,918	5,328	5,738	6,148	6,557
		120"	2,688	3,057	3,445	3,938	4,307	4,696	5,110	5,465	5,920	6,375	6,831	7,286
VALANCE		134	161	187	214	241	267	294	321	347	374	401	427	

SLIDING PANEL SURCHARGE PRICING

All tracks and valance boards over 90" wide will be spliced to avoid oversize freight charges.

		WIDTH											
		60"	72"	84"	96"	108"	120"	132"	144"	156"	168"	180"	192"
LIGHT-FILTERING LINERS Light-filtering liners are the same color on both sides. Beige Black Gray Soft White	60"	331	374	420	477	520	566	612	653	708	762	816	871
	72"	362	410	461	525	573	624	677	723	783	843	903	963
	84"	393	446	502	573	626	682	741	792	858	924	990	1,056
	96"	424	482	543	621	679	740	806	862	933	1,005	1,077	1,149
	108"	477	542	611	699	764	833	906	969	1,050	1,131	1,212	1,292
	120"	530	603	679	776	849	925	1,007	1,077	1,167	1,256	1,346	1,436
VALANCE		27	32	37	42	48	53	58	63	69	74	79	84

*If sliding panel is ordered with a liner, there will be no additional lined valance surcharge.

		WIDTH											
		60"	72"	84"	96"	108"	120"	132"	144"	156"	168"	180"	192"
BLACK-OUT LINERS Black-out liners are off white to the street. Beige Espresso White	60"	441	499	560	636	693	755	816	871	943	1,016	1,088	1,161
	72"	482	547	615	700	764	832	902	963	1,044	1,124	1,204	1,284
	84"	524	595	670	764	835	910	988	1,056	1,144	1,232	1,320	1,408
	96"	565	643	724	828	906	987	1,074	1,149	1,244	1,340	1,436	1,531
	108"	636	723	815	931	1,019	1,110	1,208	1,292	1,400	1,508	1,615	1,723
	120"	706	803	905	1,035	1,132	1,234	1,343	1,436	1,555	1,675	1,795	1,914
VALANCE		35	42	49	56	63	70	77	84	91	98	105	112

*If sliding panel is ordered with a liner, there will be no additional lined valance surcharge.

NET FREIGHT SURCHARGE*: \$40

*Freight surcharge applies for orders shipping within the continental U.S. For orders shipping to Alaska or Hawaii, please request a freight quote prior to placing your order.

NOTES

PRO DESIGN WOVEN WOOD WARRANTY

LIMITED LIFETIME WARRANTY

This product is warranted against defects in materials and workmanship, provided that:

1. The product was installed according to the product instructions.
2. Oxford House recommendations were followed regarding limitations and specifications of the product.

Oxford House, Inc reserves the right to determine if your shade warrants a repair or partial replacement of any parts. If necessary, Oxford House, Inc will replace your shade with a new shade of equal or superior value. This shall be your sole remedy under this warranty.

This Limited Lifetime Warranty excludes all motors, controls and accessories, which are warranted for only a period of five years from the date of purchase. Failure to follow the proper installation, charging and use instructions will invalidate the warranty for motors, remotes, wands and hubs.

This Limited Lifetime Warranty applies only to the original retail purchaser with proof of purchase.

This Limited Lifetime Warranty does not cover the removal or installation of original or replacement shades. This Limited Lifetime Warranty does not cover damage or defects caused by, or resulting from improper maintenance, neglect or improper use, wear and tear, abuse, neglect, accidents, alteration, commercial use, installation, removal or reinstallation or exposure to excessive moisture.

YOUR RIGHTS UNDER STATE LAW

These warranties give you specific legal rights. You may also have other rights which may vary from State to State. In no event shall Oxford House, Inc be liable for incidental or consequential damages or for any other direct or indirect damage, loss, cost, expense or fee. Some states do not allow the exclusion or limitation of incidental or consequential damages, so the above limitation or exclusion may not apply to you. These warranties are exclusive and in lieu of all other obligations, liabilities, disclaimers, or warranties.

SELECT NATURAL WOVEN

⚠️ WARNING

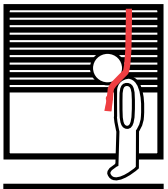

Window Blind Cord Strangulation Risk

Window blinds with a damaged or loose tension device or retractable cord that fails to fully retract pose a strangulation risk to children. To avoid this potential strangulation risk, consider purchasing cordless products with inaccessible cords.

ANSI/WCMA A100.1-2022

⚠️ ADVERTENCIA

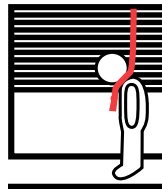

Riesgo de Estrangulamiento en Cuerdas de Persianas

Las persianas con un dispositivo tensor suelto o dañado o con una cuerda retráctable que no se ajusta completamente representan un riesgo de estrangulación para los niños. Para evitar un posible riesgo de estrangulamiento, considere comprar productos inalámbricos o productos con cuerdas inaccesibles.

ANSI/WCMA A100.1-2022